

JUDUL GAMBAR		SKALA
DENAH RENCANA KOPERASI		1 : 150
KODE	NO GAMBAR	JML. LEMBAR

01 DENAH RENCANA KOPERASI
KMP.A.0101 SKALA 1 : 150

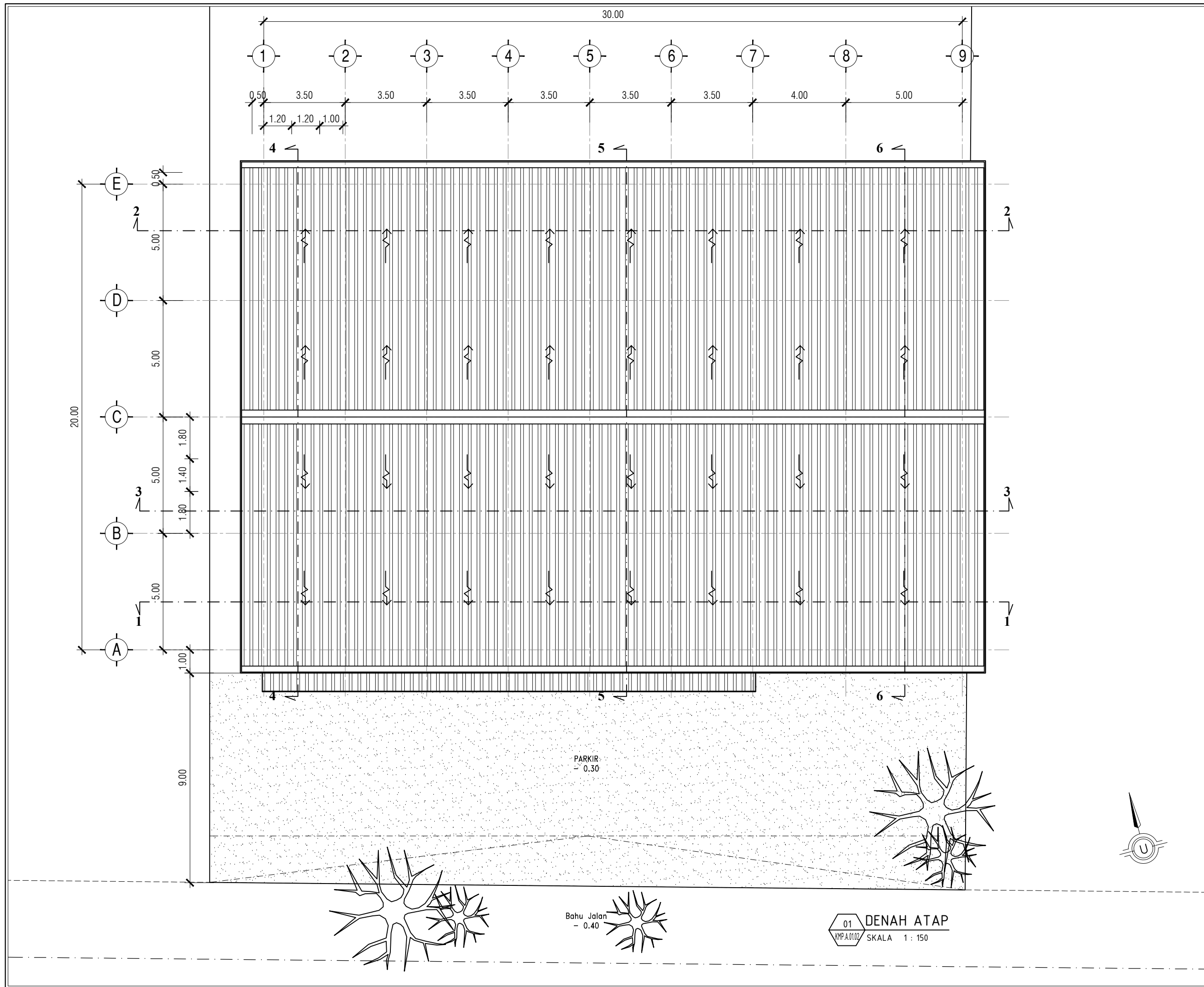

JUDUL GAMBAR		SKALA
DENAH ATAP		1 : 150
KODE	NO GAMBAR	JML. LEMBAR

01 DENAH ATAP
KMP.A.0102 SKALA 1 : 150

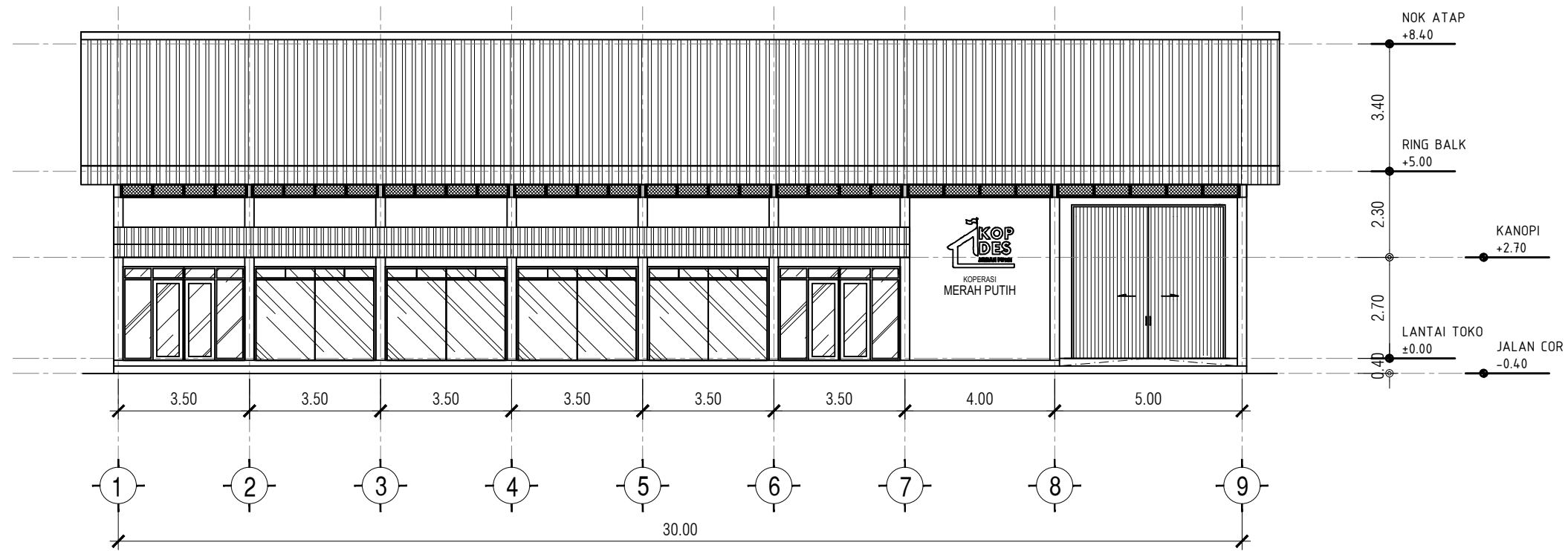

01 TAMPAK DEPAN
KMP.A.0103 SKALA 1 : 150

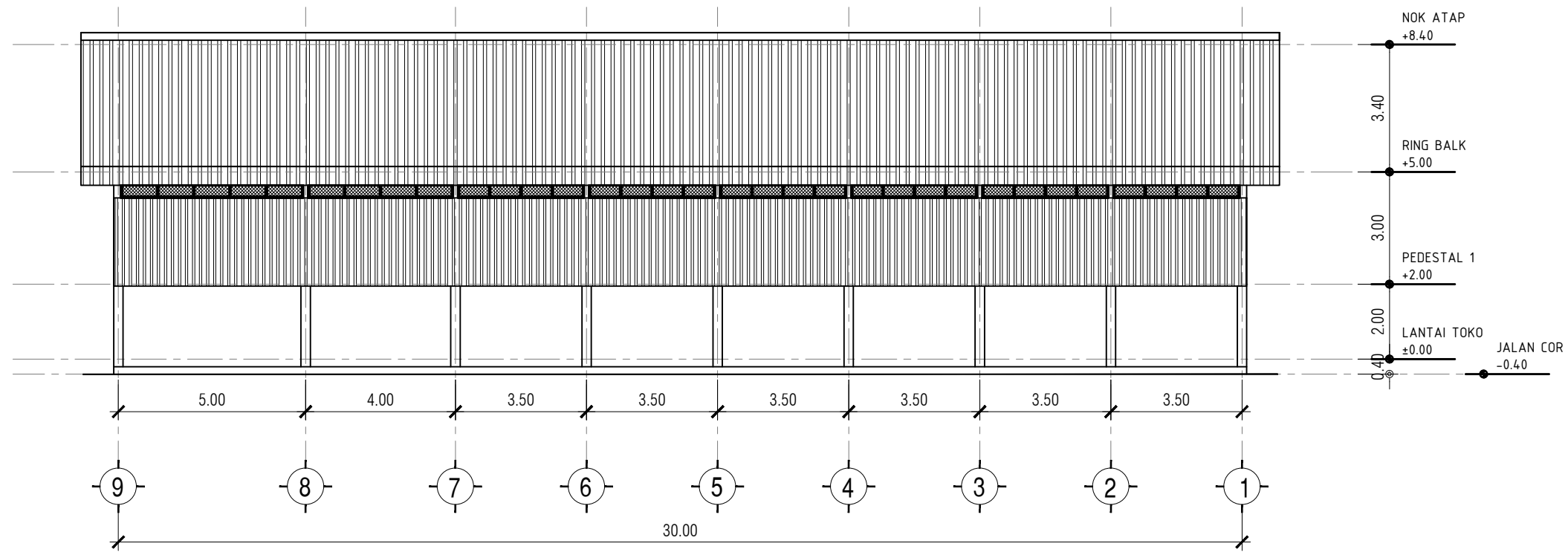

01 TAMPAK BELAKANG
KMP.A.0103 SKALA 1 : 150

JUDUL GAMBAR		SKALA
TAMPAK DEPAN TAMPAK BELAKANG		1 : 150
KODE	NO GAMBAR	JML. LEMBAR

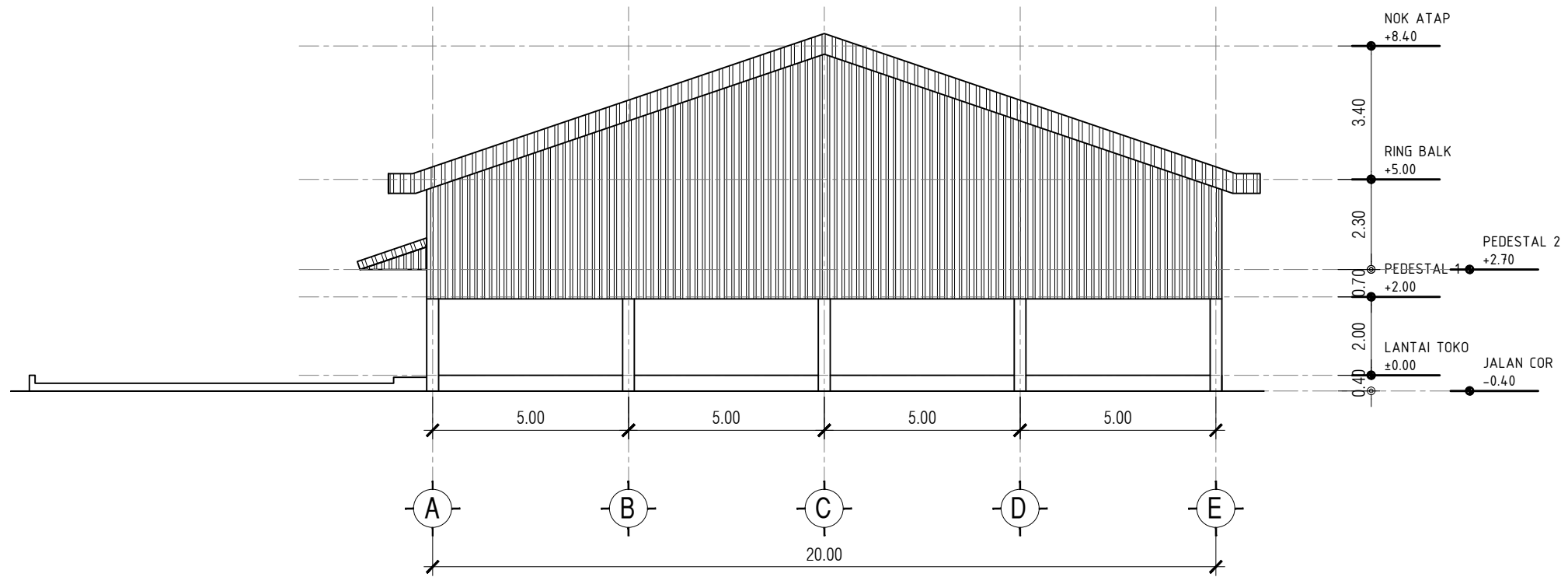

01 TAMPAK SAMPING KIRI
 KMP.A.01.04 SKALA 1 : 150

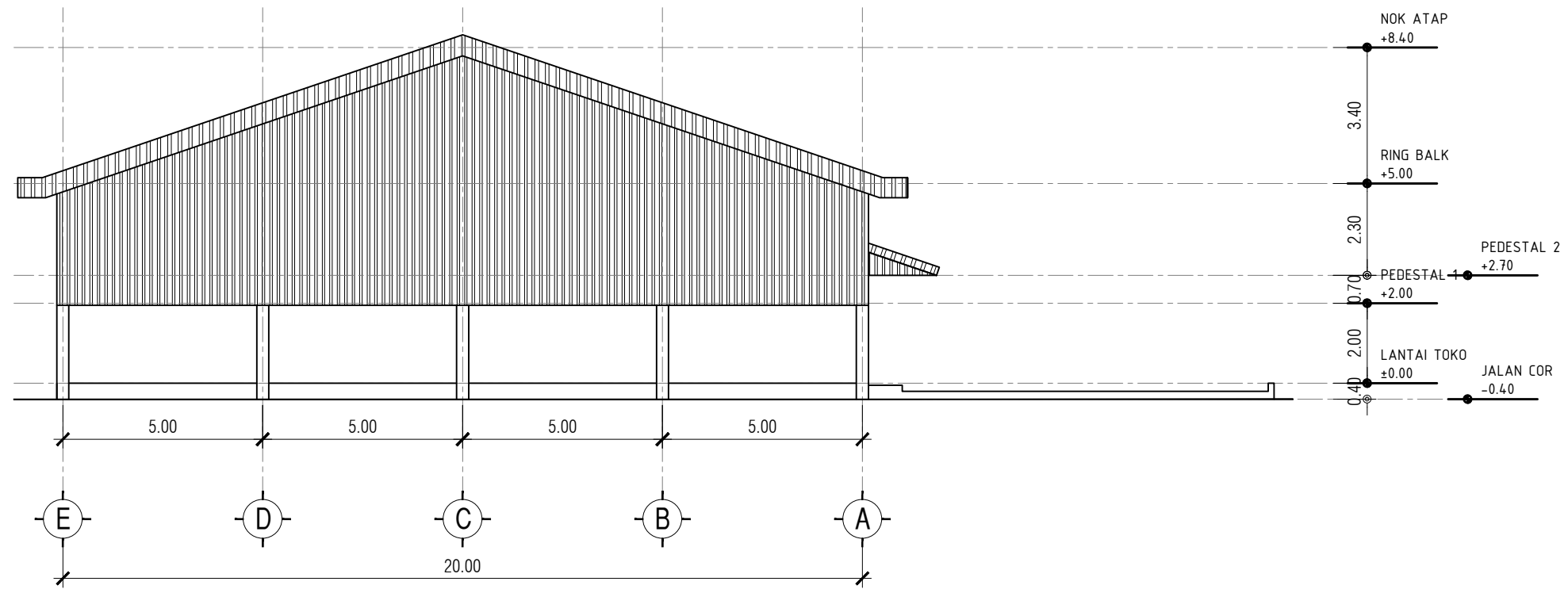

01 TAMPAK SAMPING KANAN
 KMP.A.01.04 SKALA 1 : 150

JUDUL GAMBAR		SKALA
TAMPAK SAMPING KIRI TAMPAK SAMPING KANAN		1 : 150
KODE	NO GAMBAR	JML. LEMBAR

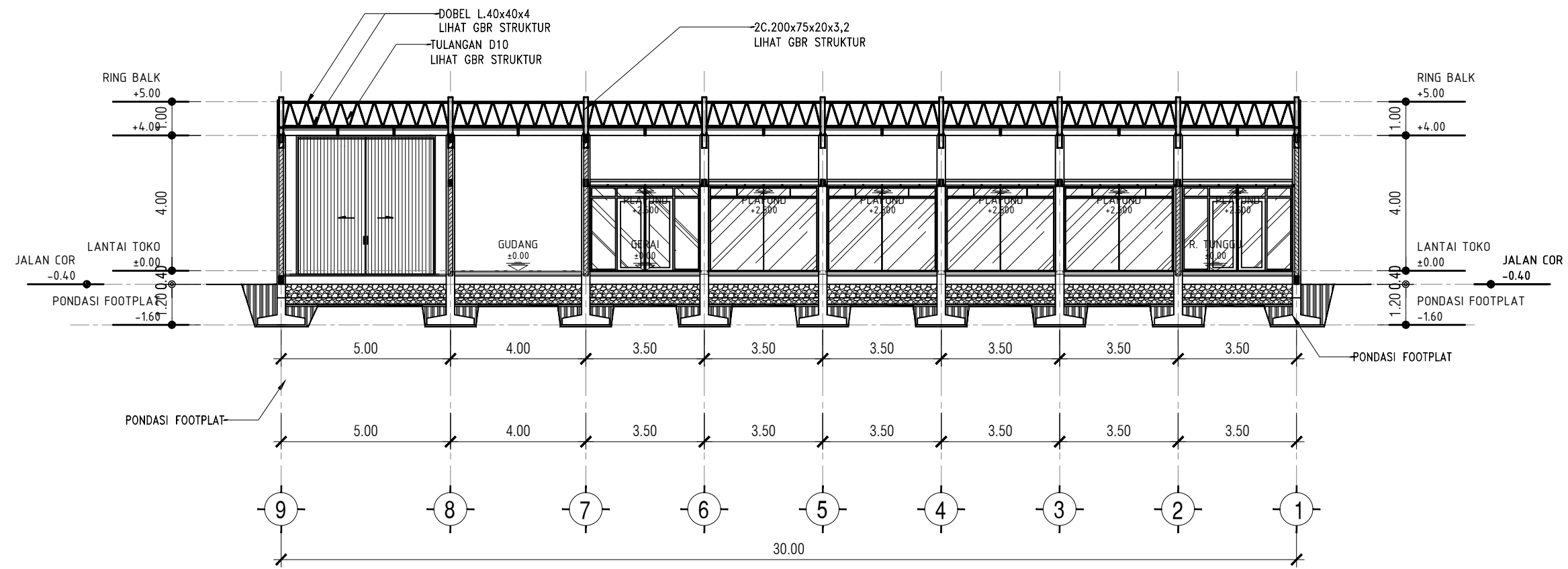

01 POTONGAN 1 - 1
SKALA 1 : 150

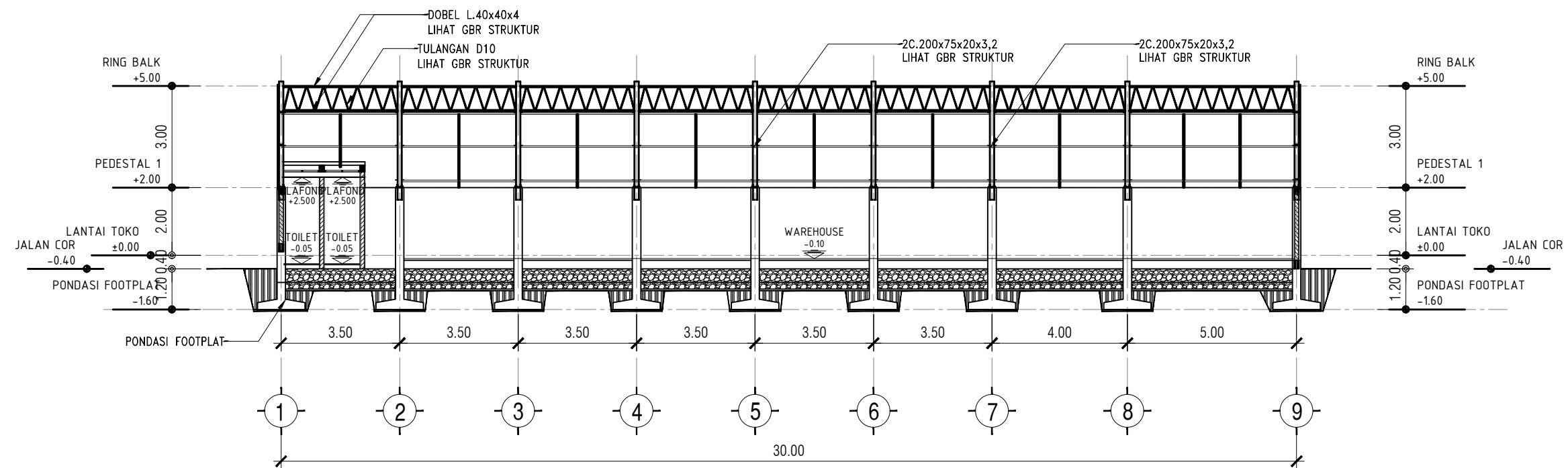

01 POTONGAN 2 - 2
SKALA 1 : 150

JUDUL GAMBAR		SKALA
POTONGAN 1 - 1 POTONGAN 2 - 2		1 : 150
KODE	NO GAMBAR	JML. LEMBAR

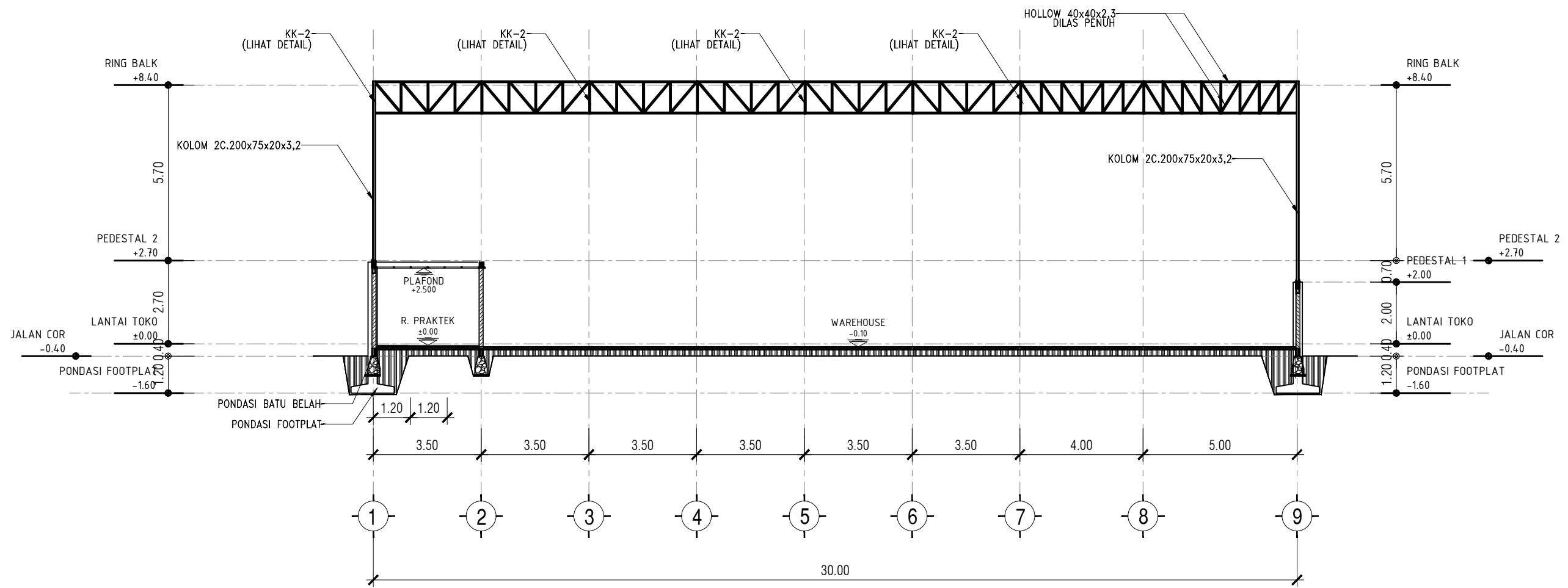

01 POTONGAN 3 - 3
 KMP.A.01.06 SKALA 1 : 150

JUDUL GAMBAR		SKALA
POTONGAN 3 - 3		1 : 150
KODE	NO GAMBAR	JML. LEMBAR

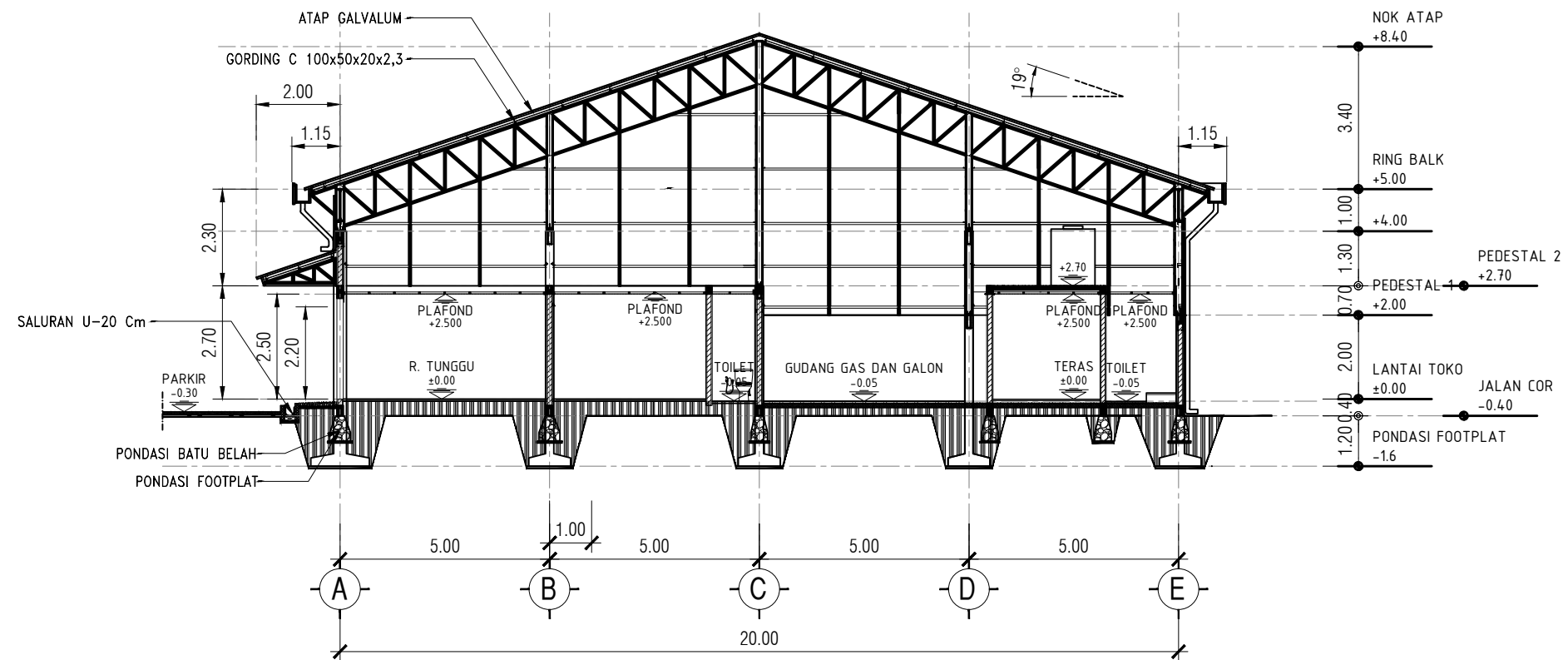

01 POTONGAN 4 - 4
KMP.A.0107 SKALA 1 : 150

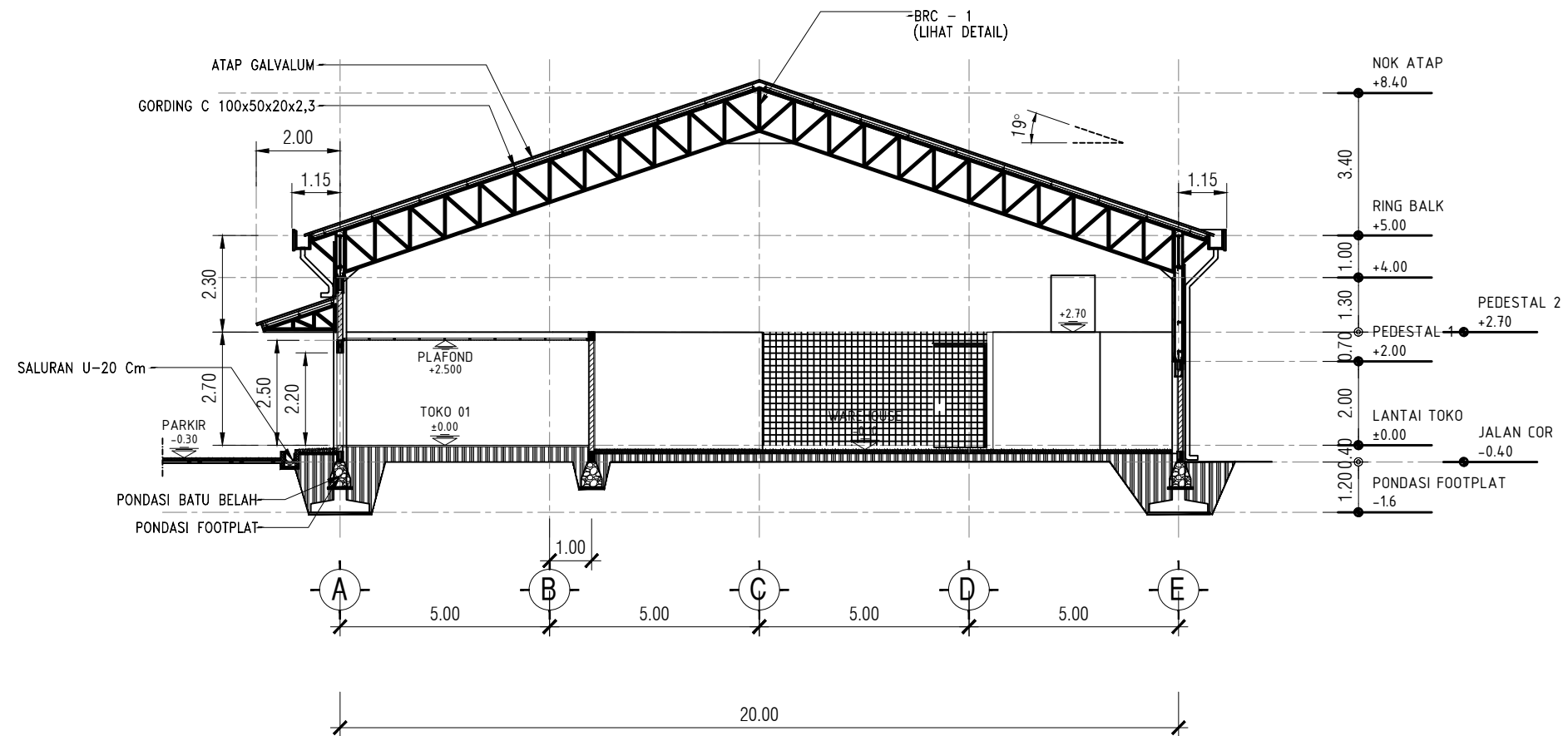

01 POTONGAN 5 - 5
KMP.A.0107 SKALA 1 : 150

JUDUL GAMBAR		SKALA
POTONGAN 4 - 4 POTONGAN 5 - 5		1 : 150
KODE	NO GAMBAR	JML. LEMBAR

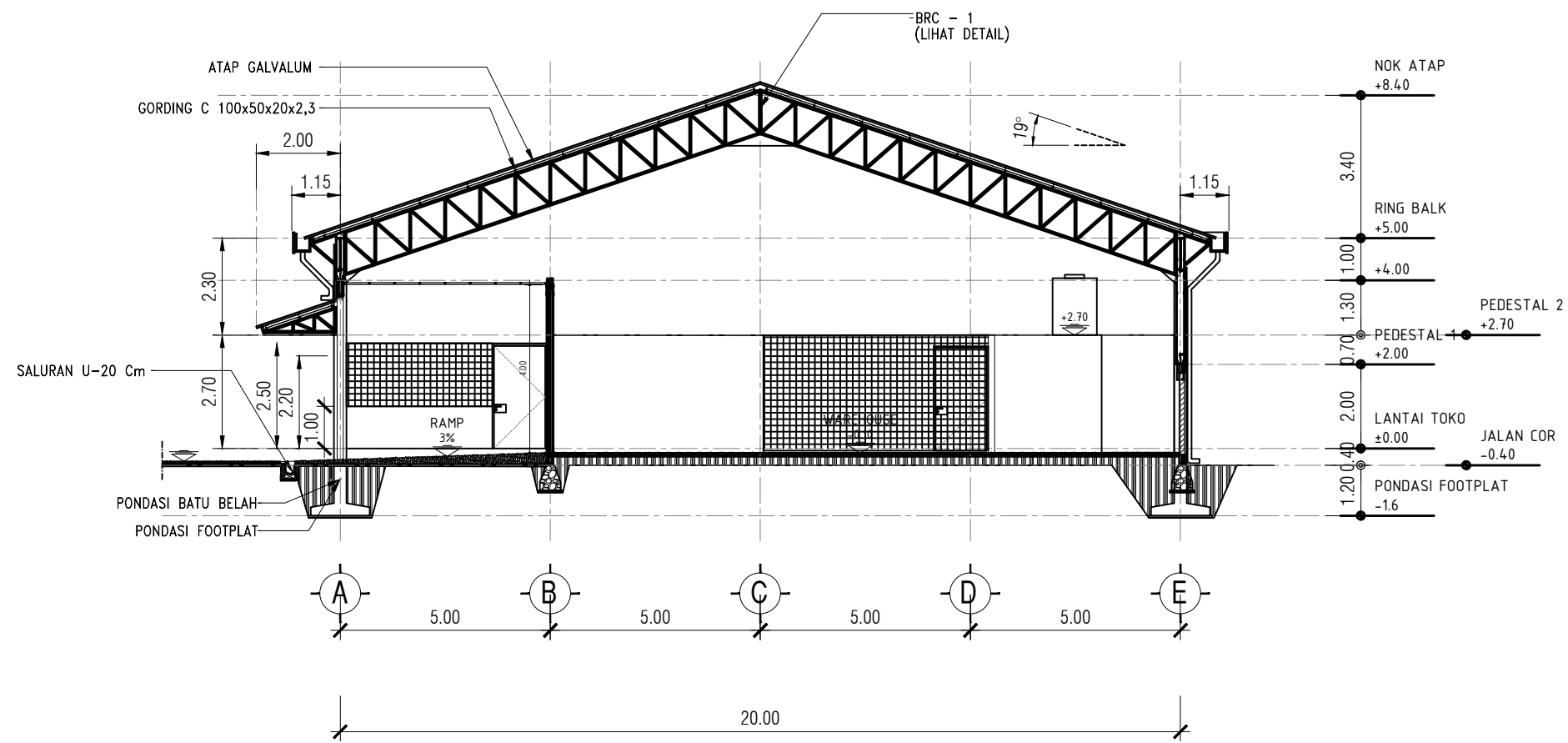

01 POTONGAN 6-6
 KMP.A.01.07 SKALA 1 : 150

JUDUL GAMBAR		SKALA
POTONGAN 4 - 4 POTONGAN 5 - 5		1 : 150
KODE	NO GAMBAR	JML. LEMBAR

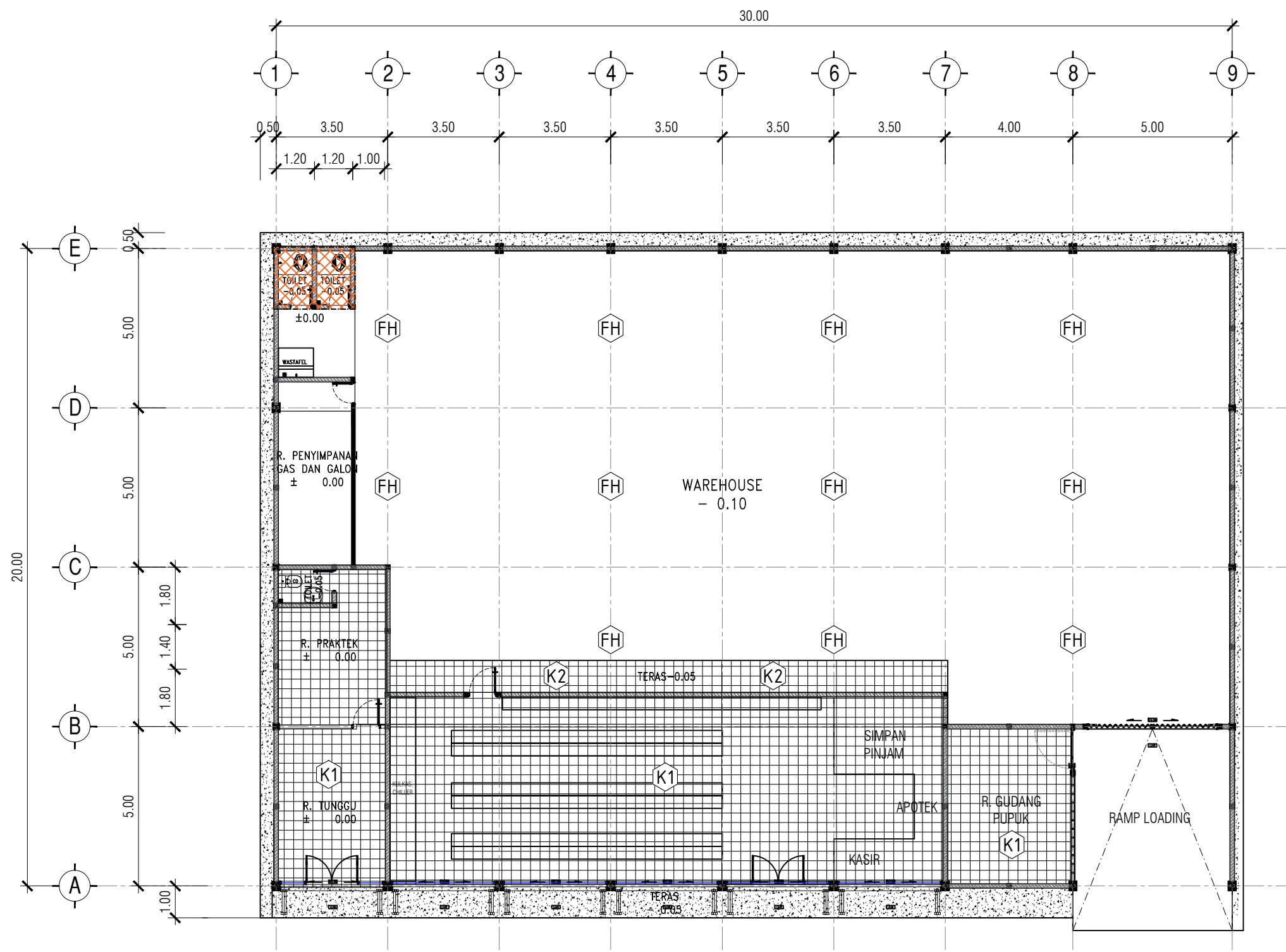

NOTASI	KETERANGAN MATERIAL LANTAI
	KERAMIK 30X30 CM POLISHED
	KERAMIK 30X30 CM UNPOLISH
	FLOOR HARDENER
	RABAT BETON
	LIHAT DETAIL LAVATORY

JUDUL GAMBAR		SKALA
DENAH POLA LANTAI		1 : 150
KODE	NO GAMBAR	JML. LEMBAR

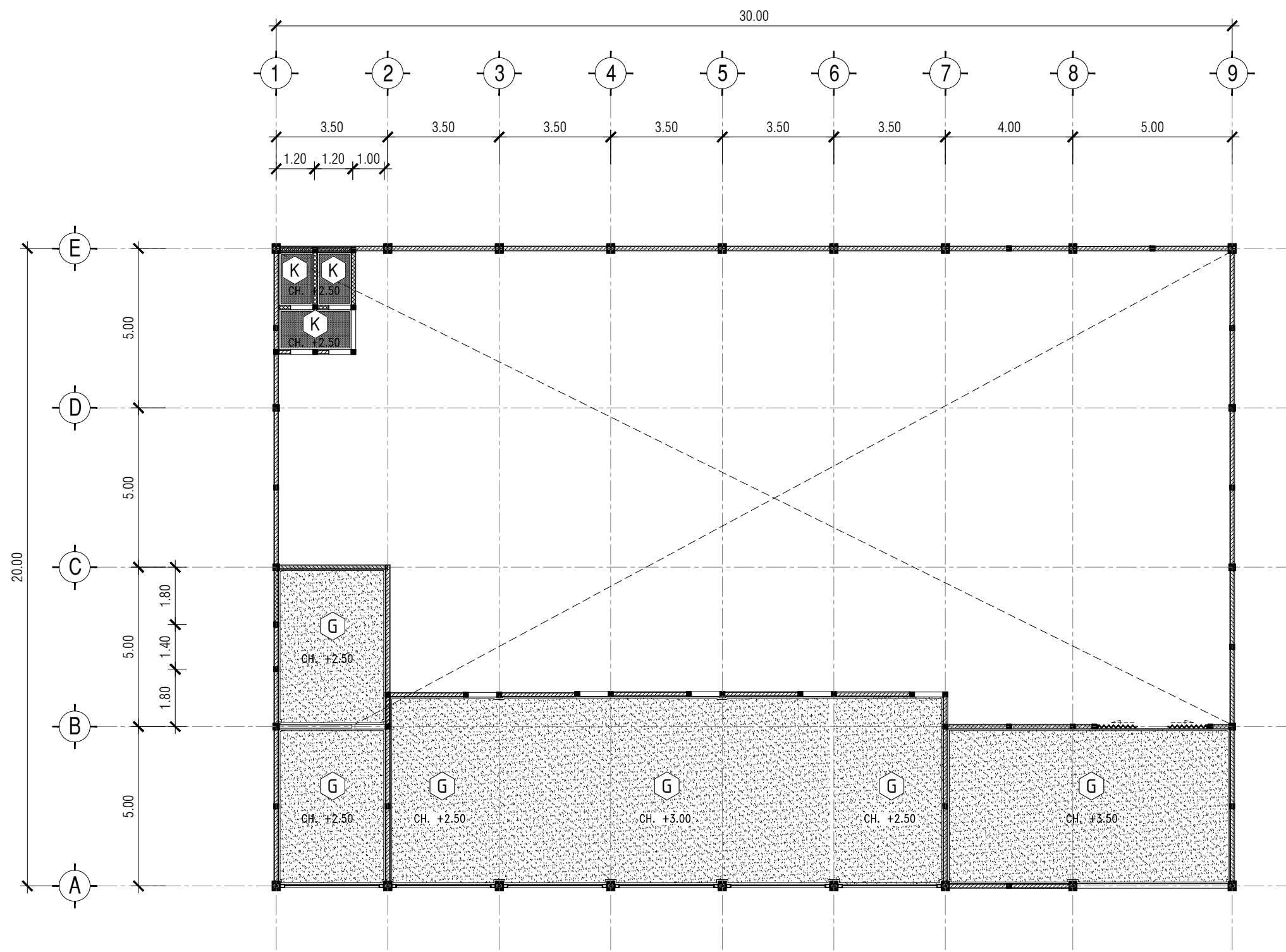

01 DENAH PLAFOND
KMP.A.01.09 SKALA 1 : 150

NOTASI	KETERANGAN PLAFOND
G	GYPSUMBOARD t=9 mm FINISHING CAT + RANGKA HOLLOW Uk. 40x40 mm
K	KALSIBOARD t=6 mm FINISHING CAT + RANGKA HOLLOW Uk. 40x40 mm
B	BETON EXPOSE FINISHING CAT

JUDUL GAMBAR		SKALA
DENAH PLAFOND		1 : 150
KODE	NO GAMBAR	JML. LEMBAR

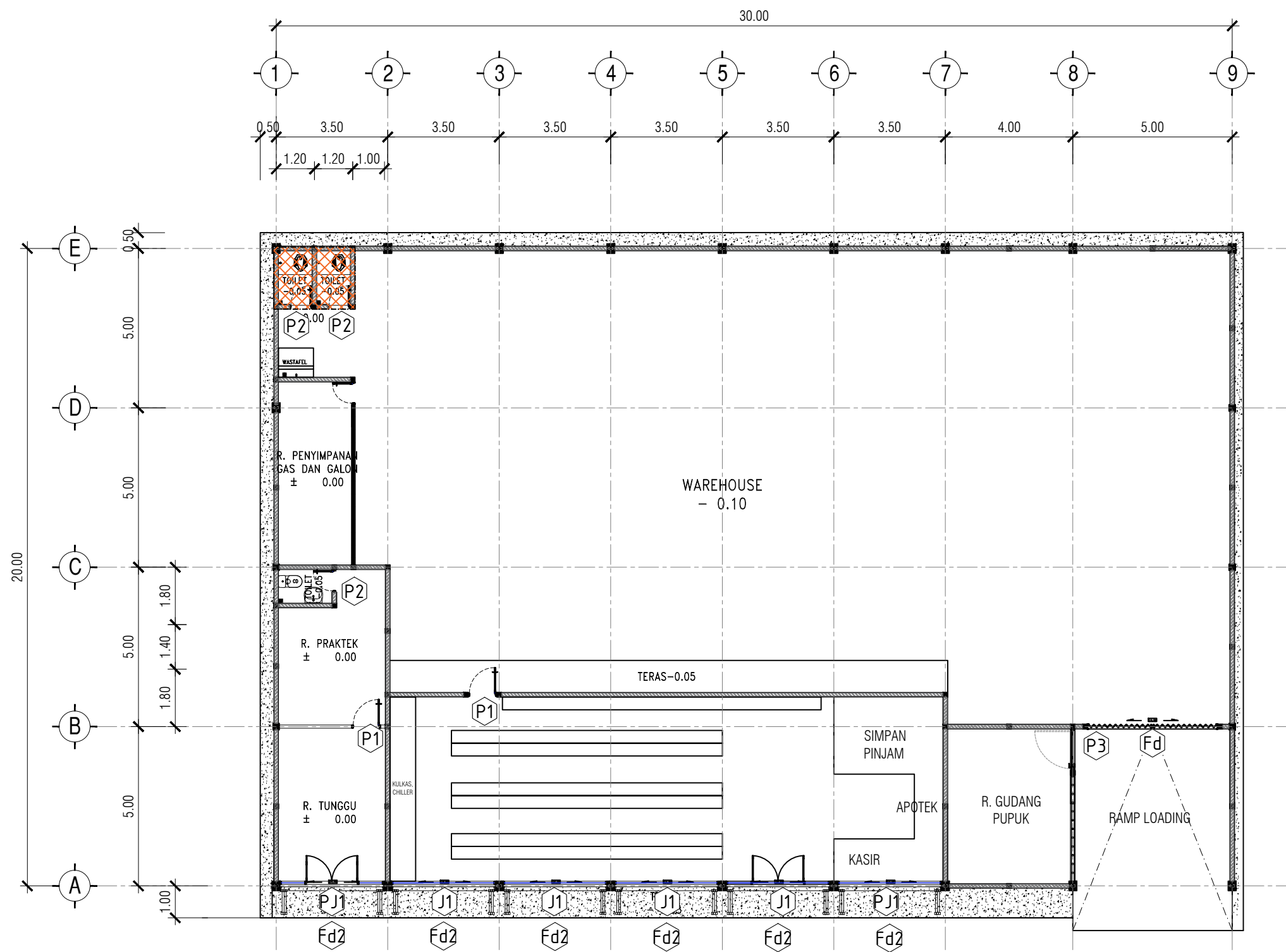

01 DENAH KUSEN
 KMP.A.01.10 SKALA 1 : 150

JUDUL GAMBAR		SKALA
DENAH KUSEN		1 : 150
KODE	NO GAMBAR	JML. LEMBAR

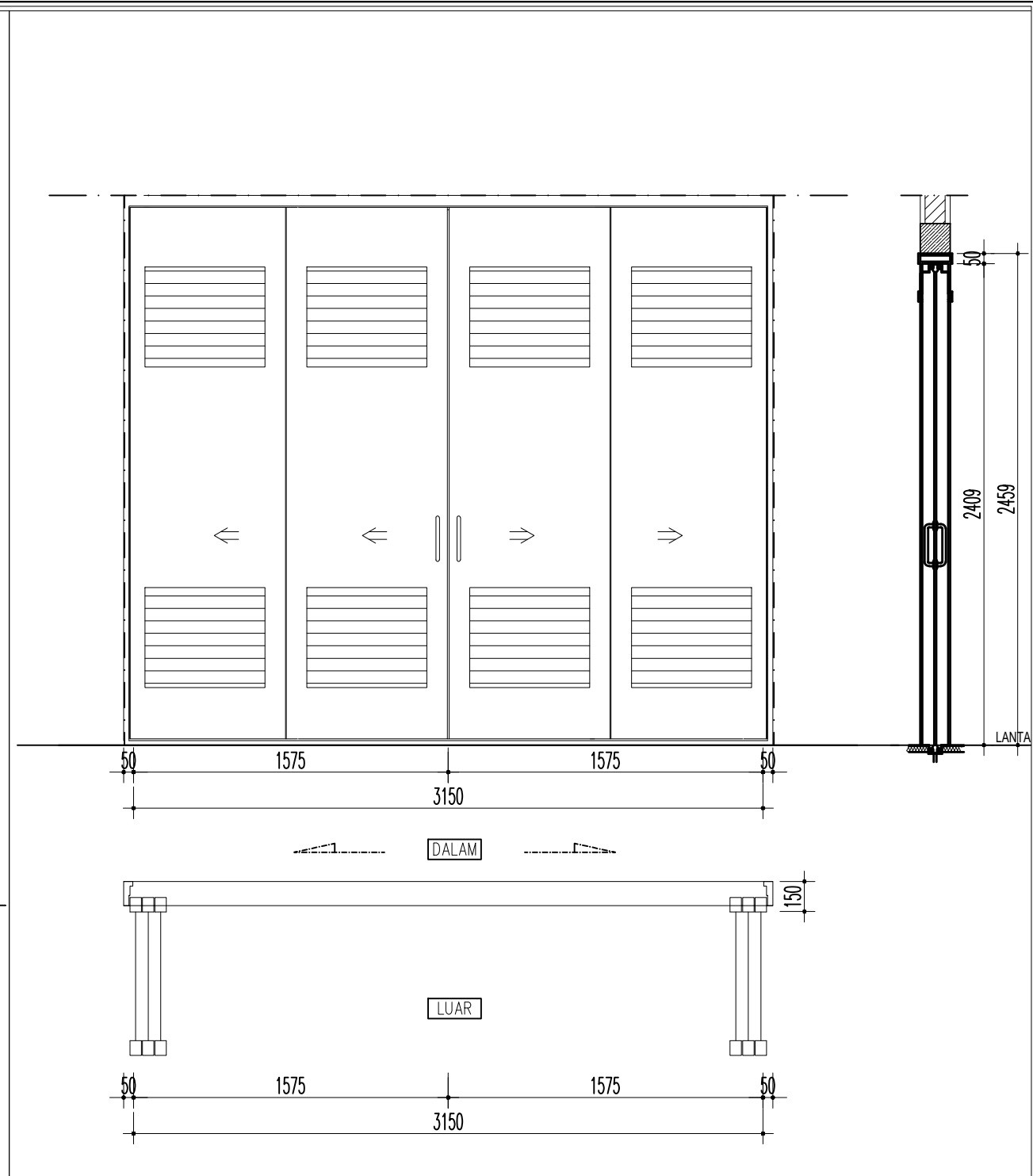
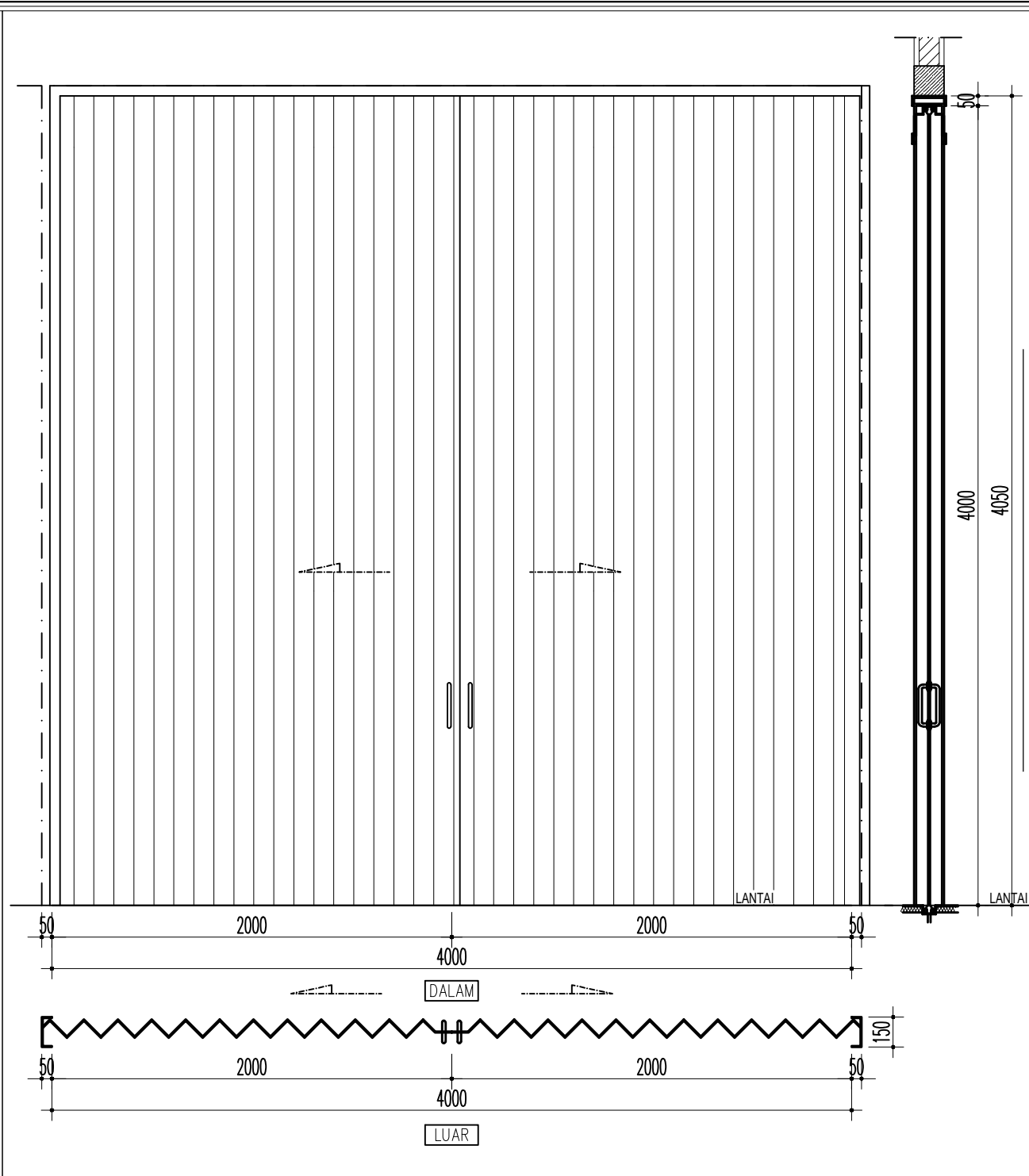

Fd1	SKALA 1 : 30	1 BUAH				
MATERIAL	FRAME	: -				
	PINTU	: FOLDING DOOR BESI FINISHING CAT BESI				
	JENDELA/BOUVEN	: -				
ASESORIES		PINTU	JENDELA	BOUVEN		
	ENGSEL / HINGES	-	-	-		
	HANDLE	-	-	-		
	KUNCI / LOCK CASE	-	-	-		
	GRENDEL / FLUSH BOLT	-	-	-		
	DOOR CLOSER	-	-	-		
	DOOR STOPER	-	-	-		
	FRICION STAY	-	-	-		
RAMBUNCIS	-	-	-			

Fd2	SKALA 1 : 30	6 BUAH				
MATERIAL	FRAME	: -				
	PINTU	: FOLDING DOOR BESI FINISHING CAT BESI				
	JENDELA/BOUVEN	: -				
ASESORIES		PINTU	JENDELA	BOUVEN		
	ENGSEL / HINGES	-	-	-		
	HANDLE	-	-	-		
	KUNCI / LOCK CASE	-	-	-		
	GRENDEL / FLUSH BOLT	-	-	-		
	DOOR CLOSER	-	-	-		
	DOOR STOPER	-	-	-		
	FRICION STAY	-	-	-		
RAMBUNCIS	-	-	-			

JUDUL GAMBAR		SKALA
DETAIL KUSEN		1 : 30
KODE	NO GAMBAR	JML. LEMBAR

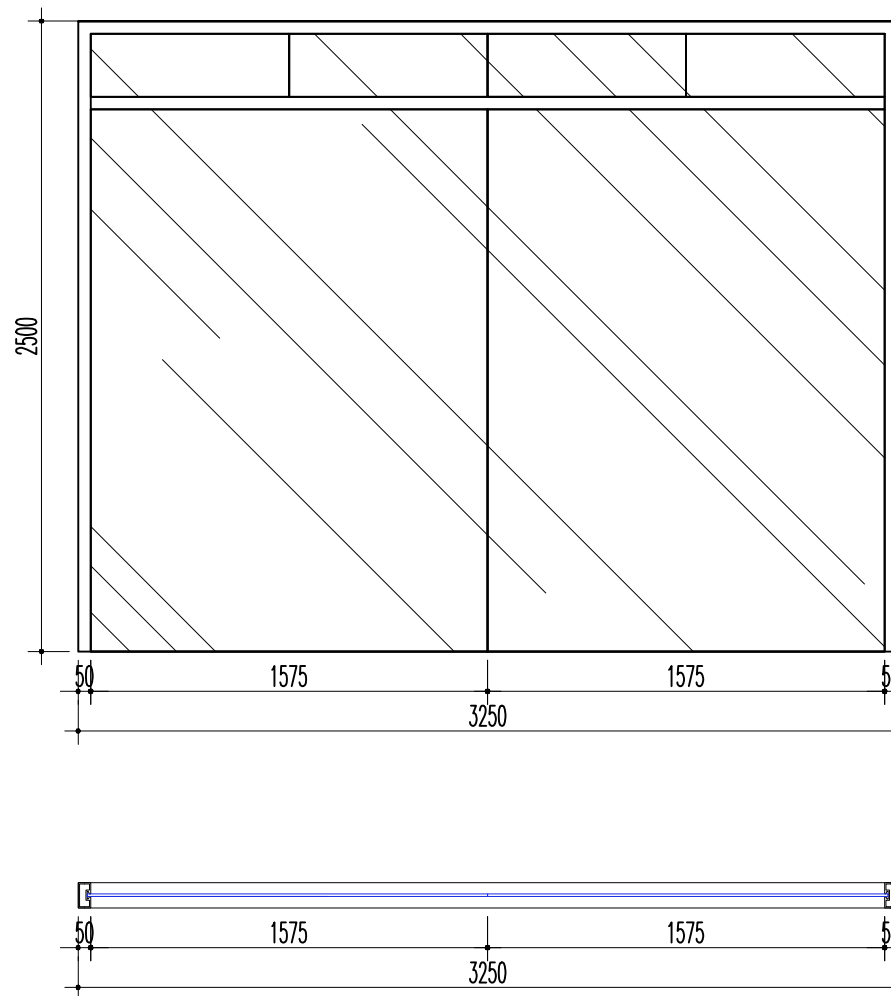
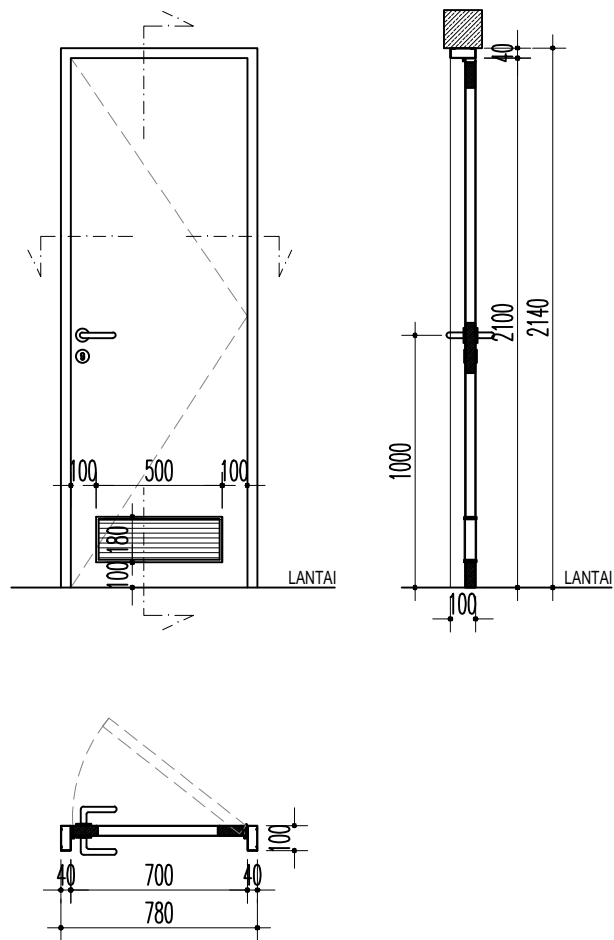

P-2	SKALA 1 : 30	3 BUAH			
MATERIAL	FRAME	: PVC			
	PINTU	: PVC			
	JENDELA/BOUVEN	: -			
ASESORIES		PINTU	JENDELA	BOUVEN	
	ENGSEL / HINGES	3 BH	-	-	
	HANDLE	1 SET	-	-	
	KUNCI / LOCK CASE	1 BH	-	-	
	GRENDEL / FLUSH BOLT	-	-	-	
	DOOR CLOSER	-	-	-	
	DOOR STOPER	-	-	-	
	FRICTION STAY	-	-	-	
	RAMBUNCIS	-	-	-	

J1	SKALA 1 : 30	4 BUAH			
MATERIAL	FRAME	: -			
	PINTU	:			
	JENDELA/BOUVEN	: JENDELA ALLUMUNIUM			
ASESORIES		PINTU	JENDELA	BOUVEN	
	ENGSEL / HINGES	-	-	-	
	HANDLE	-	-	-	
	KUNCI / LOCK CASE	-	-	-	
	GRENDEL / FLUSH BOLT	-	-	-	
	DOOR CLOSER	-	-	-	
	DOOR STOPER	-	-	-	
	FRICTION STAY	-	-	-	
	RAMBUNCIS	-	-	-	

JUDUL GAMBAR		SKALA
DETAIL KUSEN		1 : 30
KODE	NO GAMBAR	JML. LEMBAR

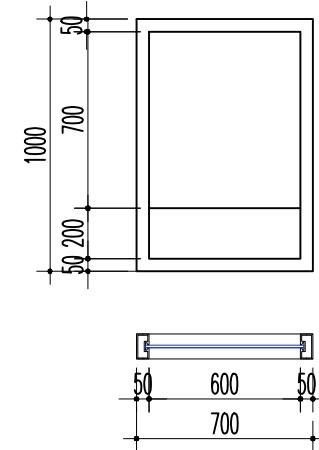
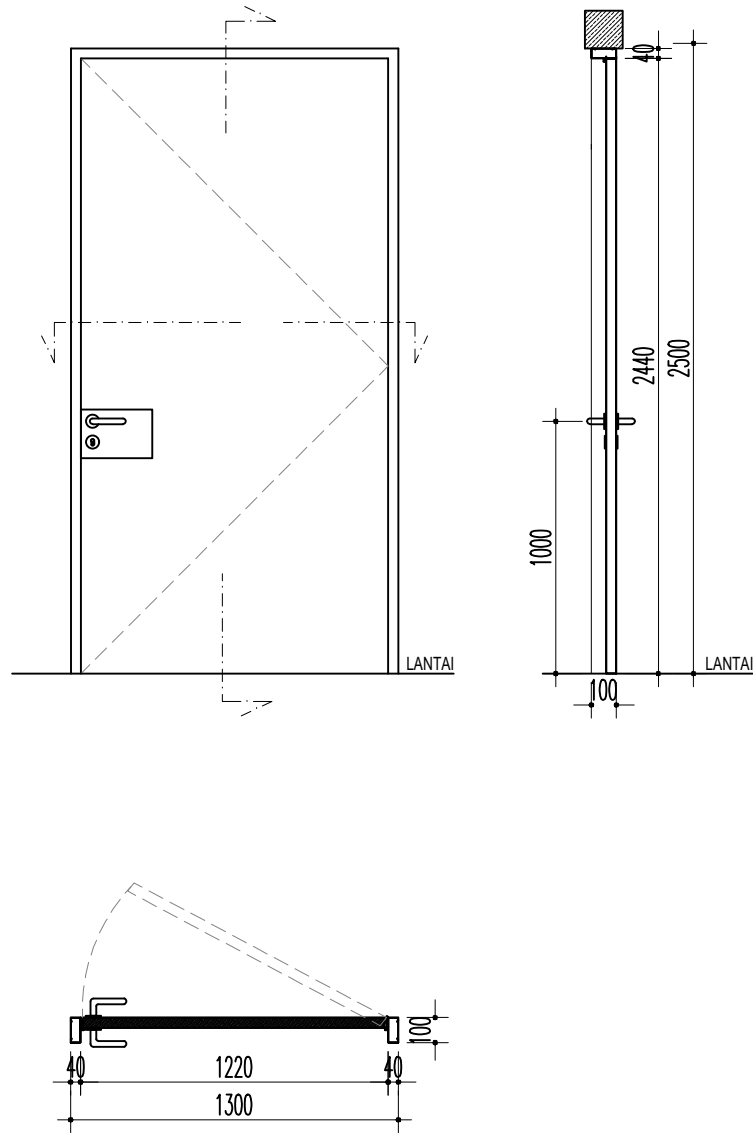

P-3	SKALA 1 : 30	1 BUAH			
MATERIAL	FRAME	: HOLLOW 100X40			
	PINTU	: PINTU BESI			
	JENDELA/BOUVEN	:			
ASESORIES		PINTU	JENDELA	BOUVEN	
	ENGSEL / HINGES	3 BH	-	-	
	HANDLE	1 SET	-	-	
	KUNCI / LOCK CASE	1 BH	-	-	
	GRENDEL / FLUSH BOLT	-	-	-	
	DOOR CLOSER	-	-	-	
	DOOR STOPER	-	-	-	
	FRICION STAY	-	-	-	
RAMBUNCIS	-	-	-		

J1	SKALA 1 : 30	1 BUAH			
MATERIAL	FRAME	: -			
	PINTU	:			
	JENDELA/BOUVEN	: JENDELA LOKET			
ASESORIES		PINTU	JENDELA	BOUVEN	
	ENGSEL / HINGES	-	-		
	HANDLE	-	-		
	KUNCI / LOCK CASE	-	-		
	GRENDEL / FLUSH BOLT	-	-		
	DOOR CLOSER	-	-		
	DOOR STOPER	-	-		
	FRICION STAY	-	-		
RAMBUNCIS	-	-			

JUDUL GAMBAR		SKALA
DETAIL KUSEN		1 : 30
KODE	NO GAMBAR	JML. LEMBAR

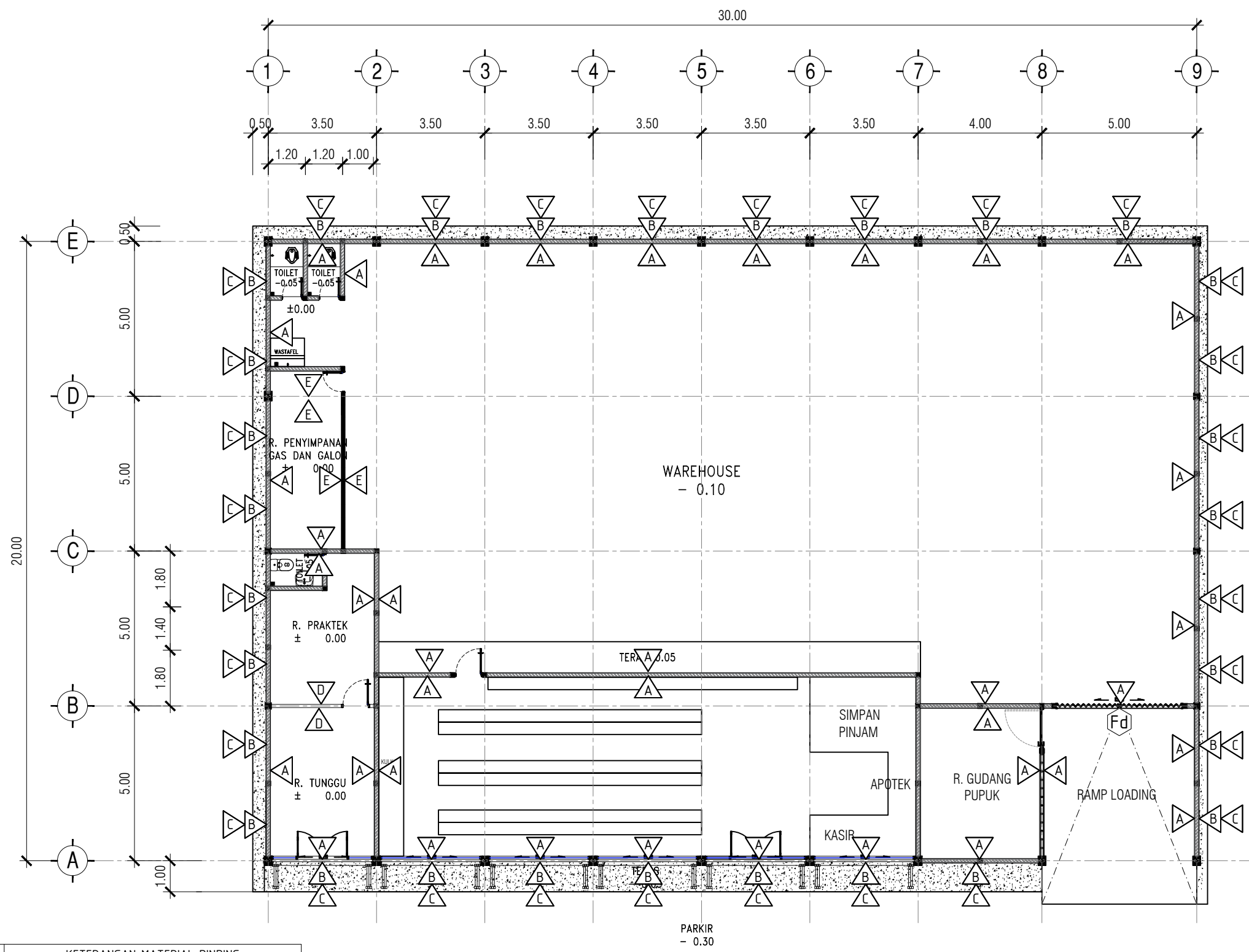

NOTASI	KETERANGAN MATERIAL DINDING
	FINISHING CAT INTERIOR
	FINISHING CAT EKSTERIOR (CAT WEATHER SHIELD)
	UPVC SINGLE LAYER
	DINDING PARTISI GYPSUM 9mm
	WIREMESH M6-150
	LIHAT DETAIL

01 DENAH MATERIAL DINDING
 KMP.A.01.13 SKALA 1 : 150

JUDUL GAMBAR		SKALA
DENAH MATERIAL DINDING		1 : 150
KODE	NO GAMBAR	JML. LEMBAR

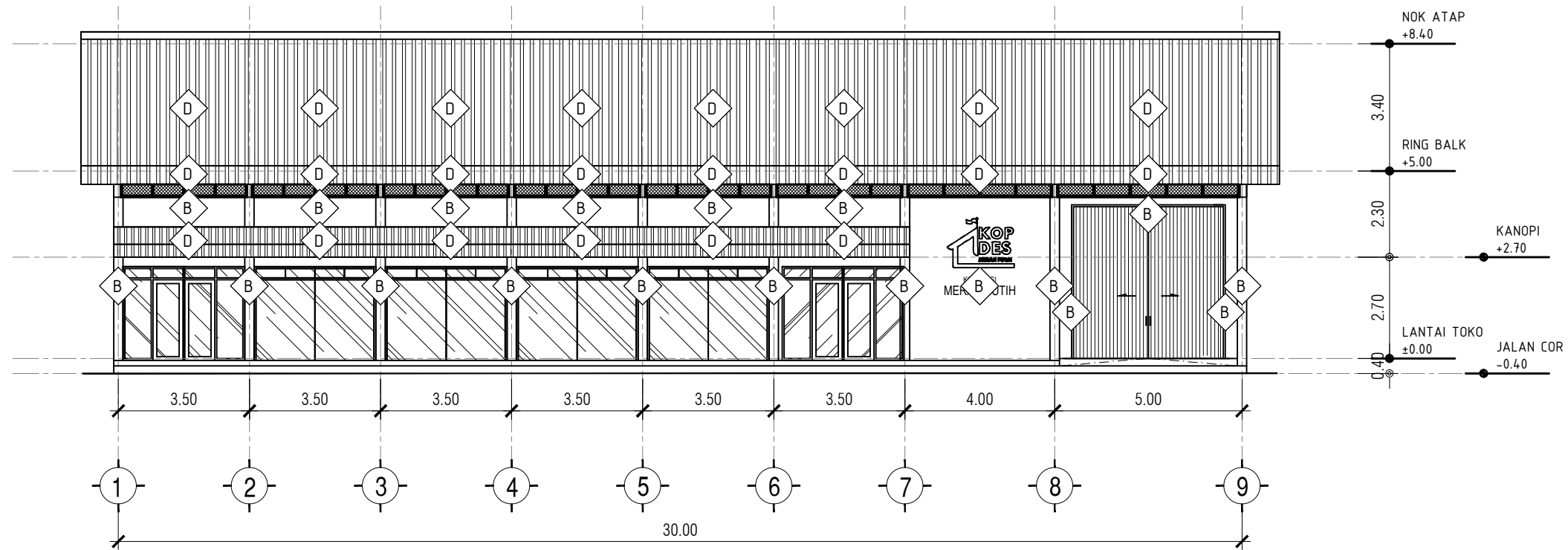

01 MATERIAL TAMPAK DEPAN
KMP.A.0114 SKALA 1 : 150

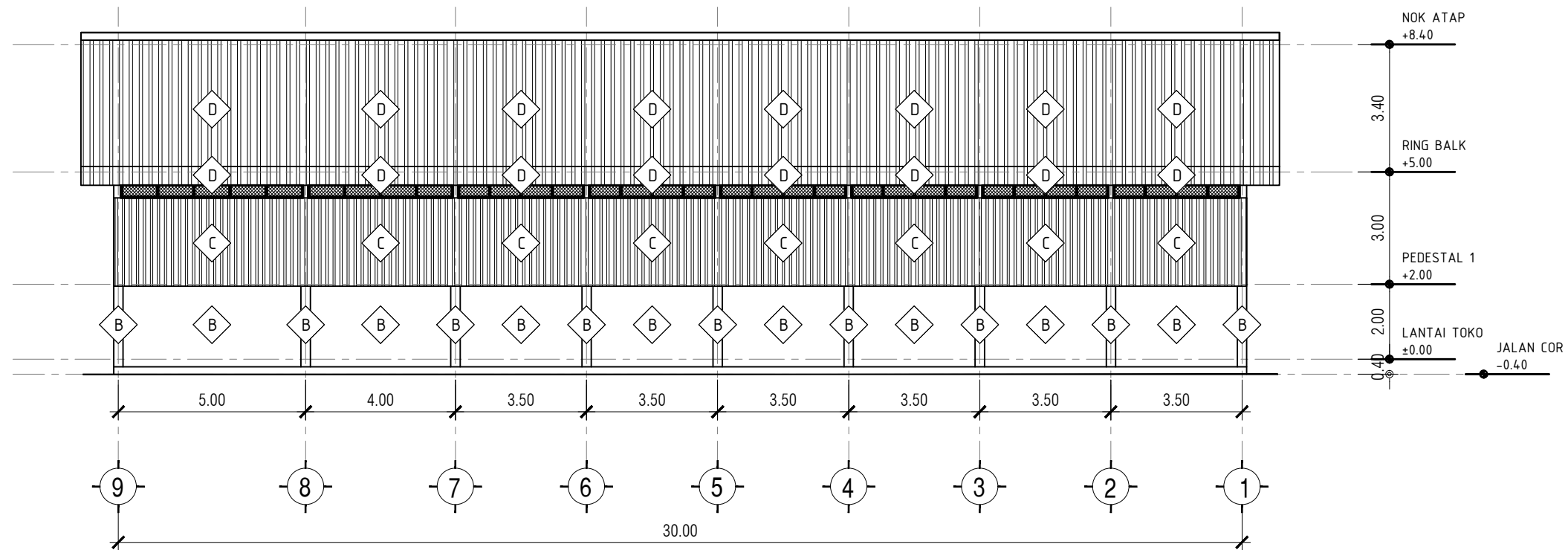

01 MATERIAL TAMPAK BELAKANG
KMP.A.0114 SKALA 1 : 150

NOTASI	KETERANGAN MATERIAL
B	FINISHING CAT EKSTERIOR (CAT WEATHER SHIELD)
C	UPVC SINGLE LAYER/ZINCALUME/SENG GELOMBANG (SETARA)
D	ATAP UPVC SINGLE LAYER/ZINCALUME/SENG GELOMBANG (SETARA)

JUDUL GAMBAR		SKALA
MATERIAL TAMPAK DEPAN MATERIAL TAMPAK BELAKANG		1 : 150
KODE	NO GAMBAR	JML. LEMBAR

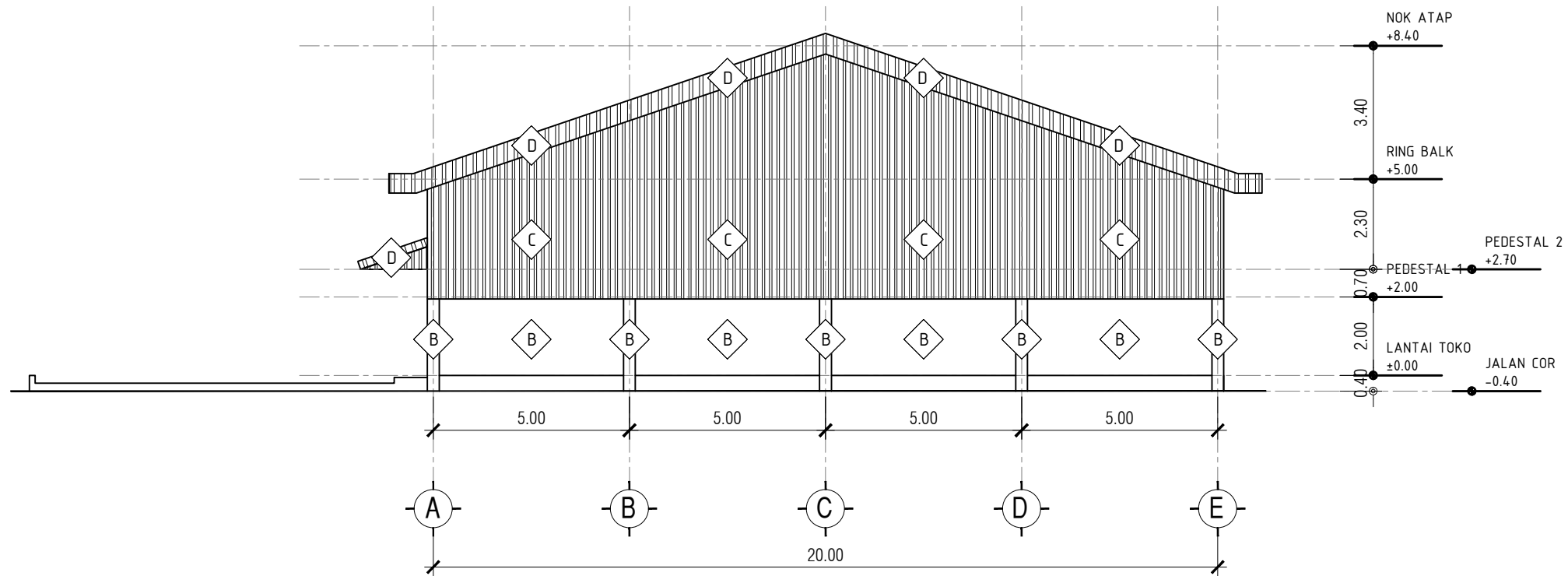

01 MATERIAL TAMPAK SAMPING KIRI
KMP.A.01.15 SKALA 1 : 150

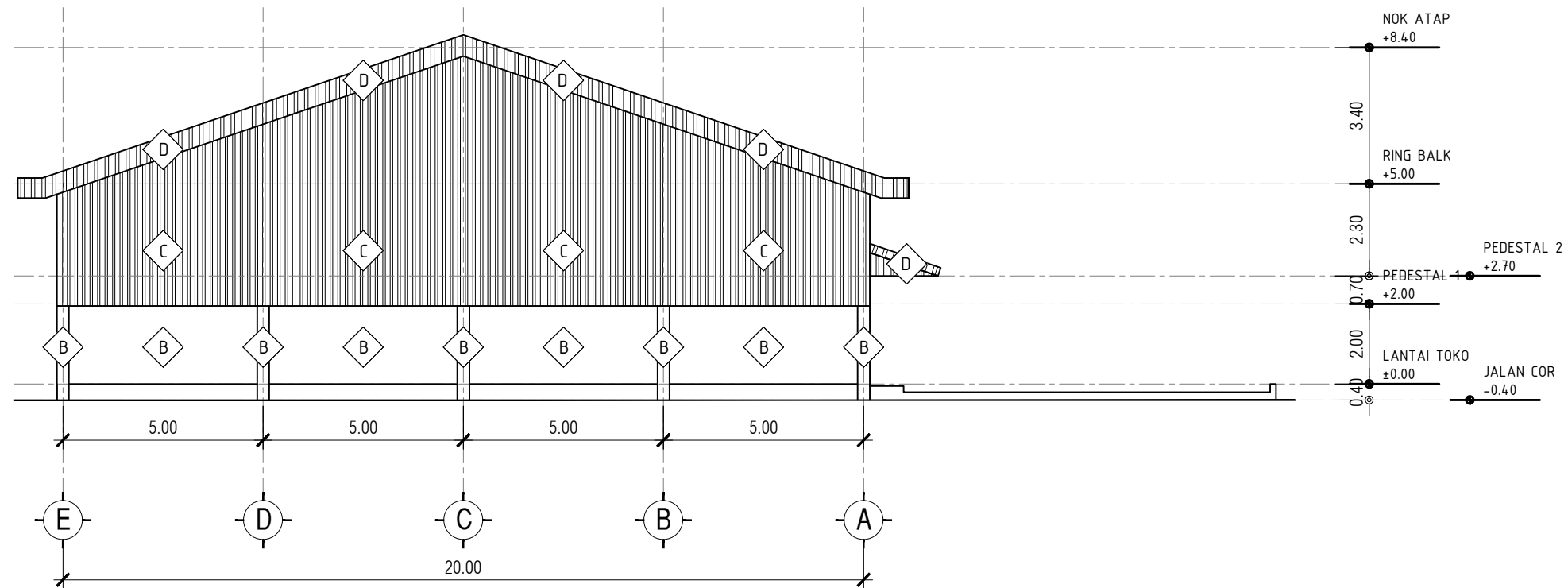

01 MATERIAL TAMPAK SAMPING KANAN
KMP.A.01.15 SKALA 1 : 150

NOTASI	KETERANGAN MATERIAL
B	FINISHING CAT EKSTERIOR (CAT WEATHER SHIELD)
C	UPVC SINGLE LAYER/ZINCALUME/SENG GELOMBANG (SETARA)
D	ATAP UPVC SINGLE LAYER/ZINCALUME/SENG GELOMBANG (SETARA)

JUDUL GAMBAR		SKALA
MATERIAL TAMPAK DEPAN MATERIAL TAMPAK BELAKANG		1 : 150
KODE	NO GAMBAR	JML. LEMBAR

KODE	KETERANGAN
CJ	CLOSED JONGKOK
FD	FLOOR DRAIN
KR	KRAN
K1	KERAMIK 30x30 cm UNPOLISH
K2	KERAMIK 30x30 cm POLISH
F1	FINISHING CAT INTERIOR (ANTI JAMUR/LEMBAB)

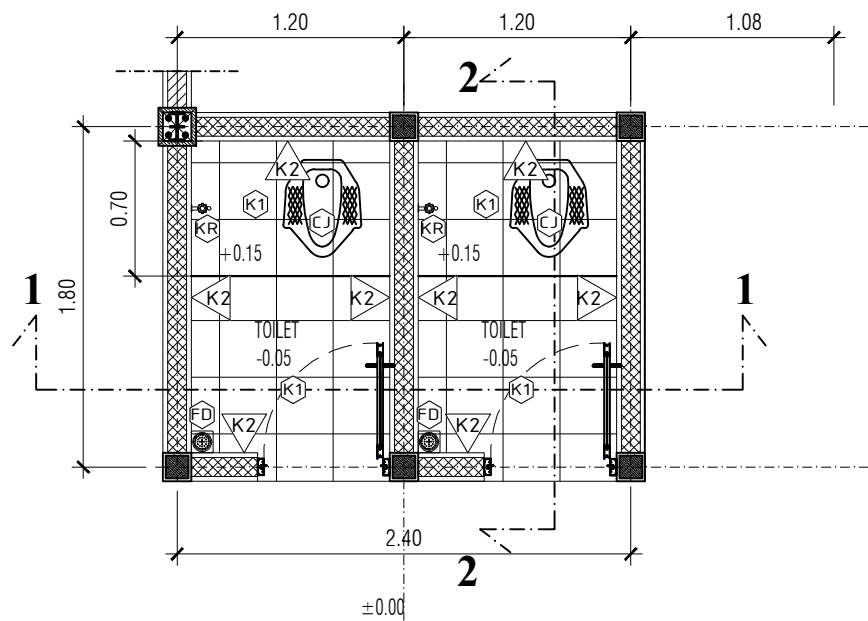

01 DENAH LAVATORY
KMP.A.01.16 SKALA 1 : 40

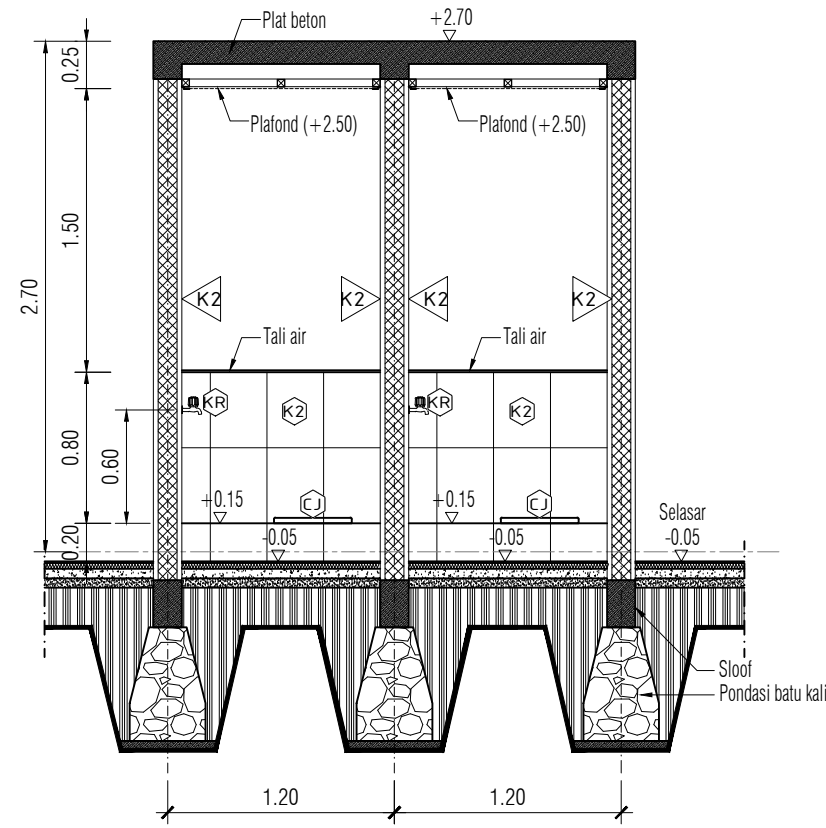

01 POTONGAN 1 - 1
KMP.A.01.16 SKALA 1 : 40

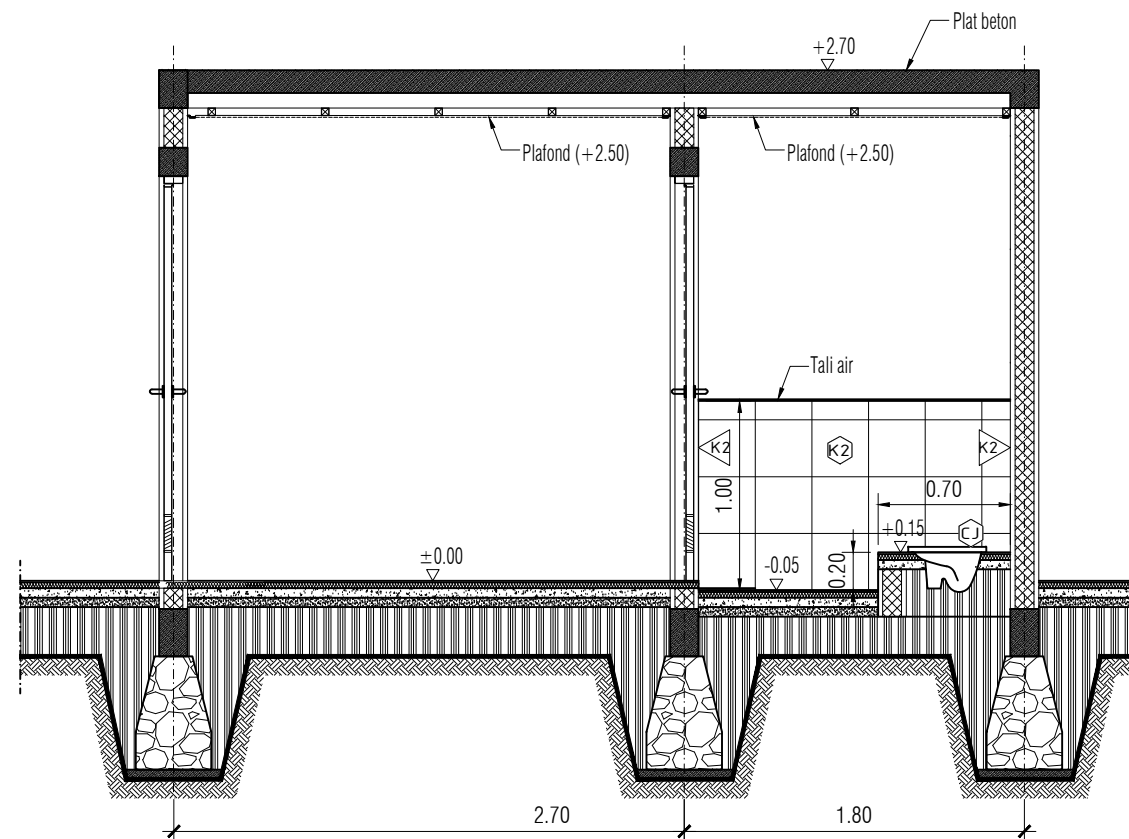

01 POTONGAN 2 - 2
KMP.A.01.16 SKALA 1 : 40

JUDUL GAMBAR		SKALA
DETAIL LAVATORY		1 : 40
KODE	NO GAMBAR	JML. LEMBAR